

820-250/250-0П

Production according to TR 3113-003-15365247-2009

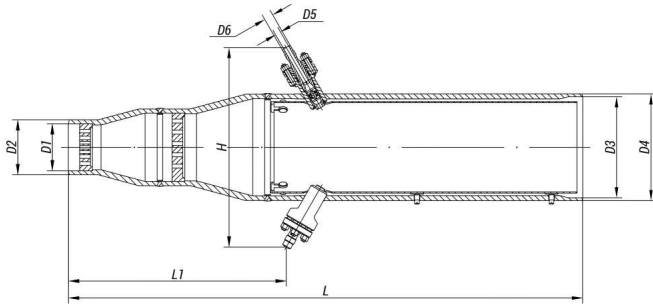

Connection: welded connection.

Structural versions: various designs depending on operating parameters of live and reduced cooled steam. They differ from each other in dimensions, injection unit version and structure of atomizing devices, as well as in the number of throttle grids.

Material of desuperheater bodies: steel of type 12X1MΦ, 15X1M1Φ.

Specifications

DN, mm	Pp, MPa	T, °C	Work ing Medium	L, mm	L1, mm	H, mm	D1, mm	D2, mm	D3, mm	D4, mm	D5, mm	D6, mm	Full Weigh t, kg	S1, cm2	S2, cm2	S3, cm2	S4, cm2	S5, cm2	S6, cm2
250	14,0	570	Пар	1150	45	320	251	345	251	325	20	32	360	0	0	0	0	0	0

The steam desuperheaters are intended for steam cooling-down and form an integral part of DS, PRDS and FRPRDS. The steam is cooled-down in the desuperheater thanks to injection of cooling water or steam-water mixture.

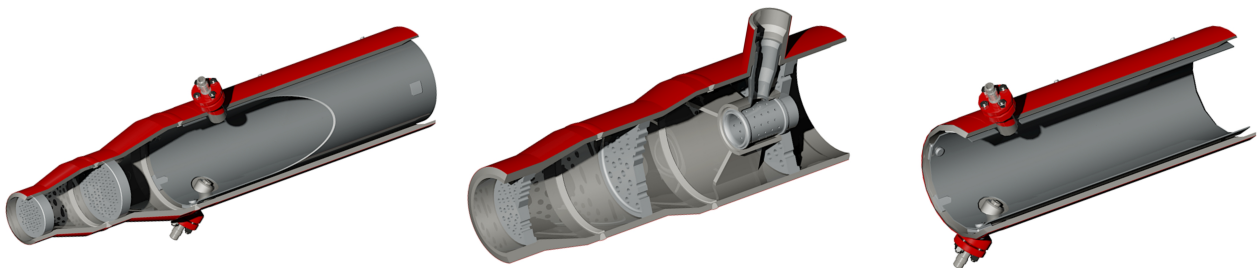

The cooling water is injected with the help of atomizing devices (nozzles of mechanical and steam atomization, atomizing inserts or spraying jets), the flow through which is regulated with an injection valve. A signal for the flow control of cooling water is given at the temperature of the cooled steam in the pipeline behind the steam desuperheater. The steam desuperheaters may be equipped with one or several throttle grids which perform final steam reducing after the pressure reducing valve (for PRDS, FRPRDS).

The grids also serve as noise dampers simultaneously, while reducing the noise level during steam expansion in the desuperheater. Installation: on horizontal and vertical pipeline sections behind the steam reducing valve.

The table demonstrates typical steam desuperheaters. However, the majority of steam desuperheaters is individually designed for specific operation conditions.

Page link:

<https://en.bkzn.ru/catalog/rou-brou-ou-ru-oborudovanie/oxladiteli-na-vysokie-parametry-para/820-250250-op/>