

13c-2-8

Production according to TR 3113-003-15365247-2009

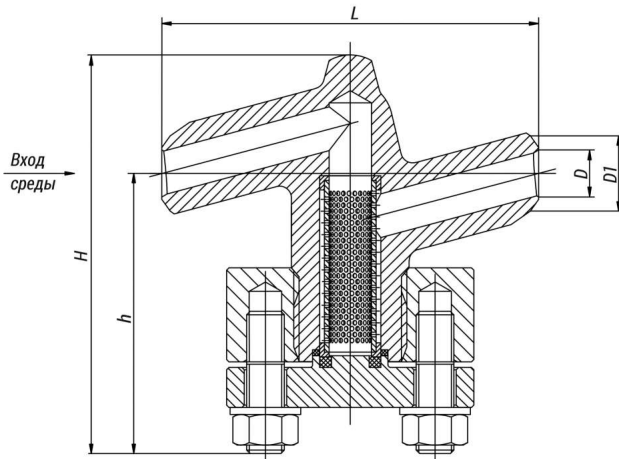

Pipeline connection: welded connection.

Installation position: any position on the pipeline, in the lower semi-sphere with regard to the neck. The filters are intended for outdoor installation and installation in closed premises.

Working medium supply direction: under the filtering element.

Climatic version: У, УХЛ, Т according to GOST 15150-69.

Placement category: 1, 2, 3 according to GOST 15150-69.

Specifications

DN, mm	PN, MPa	Tmax of the Medium, °C	Body Material, Steel	Working Medium	L, mm	H, mm	h, mm	D, mm	D1, mm	Full Weight, kg
65	23,5*	250	20	Вода	250	295	200	58	76	28,3

The main purpose is to prevent channel clogging of water and steam-water nozzles of steam desuperheaters on the pressure-reducing and desuperheating stations.

The filters of type 13c for steam and water refer to the elements of excess rpressure pipelines.

According to GOST 356-80, the items designed for the ultimate pressure allow their application on operating parameters within the following range:

- at PN 10 MPa – from 10 MPa, 200 °C to 3,6 MPa, 455 °C;
- at PN 25 MPa – from 25 MPa, 200 °C to 9 MPa, 455 °C;
- at PN 6,3 MPa – from 6,3 MPa, 200 °C to 2,3 MPa, 455 °C.

The permissible values of operating pressures and temperatures for the filters may differ from those ones indicated in the table with technical specifications and shall be chosen according to GOST 356-80.

Page link:

<https://en.bkzn.ru/catalog/rou-brou-ou-ru-oborudovanie/filtry-setchatye-13s/13c-2-8/>