

T-31MC-2

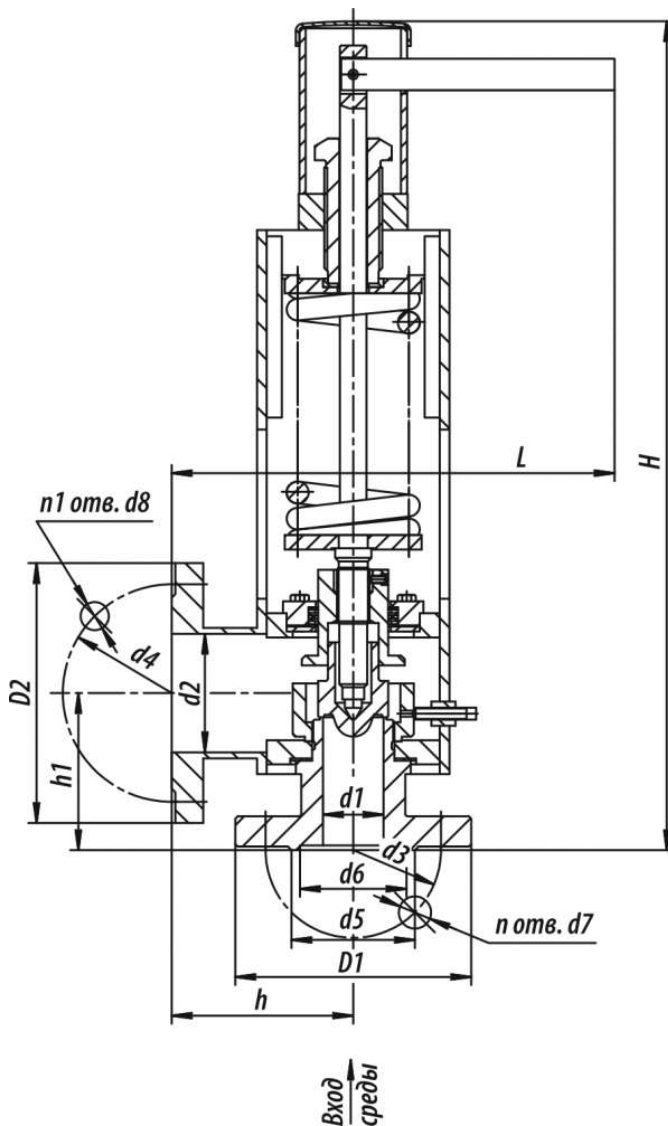

Production according to TR 2913-001-15365247-2004

Pipeline connection:

- threaded-end connection;
- flanged connection.

The connection is designed for loads from the valve weight and reactive forces appearing in case of the valve activation.

Installation position: vertically in the highest part of the site protected.

Climatic version: У, УХЛ, ХЛ, Т according to GOST 15150-69.

Placement category: 2, 3 according to GOST 15150-69.

Specifications

DN, mm	PN, MPa	Max of the Medium, °C	Body Material, Steel	Working Medium	Operating Stroke, mm	F, cm ²	Adjustment Range of PH Valve, MPa	μ, not less than	Inlet/Outlet Diameter, mm	d1, mm	d2, mm	d3, mm	d4, mm	d5, mm	d6, mm	d7, mm	d8, mm	L, mm	H, mm	h, mm	D1, mm	D2, mm	n	h1, mm	n1	Full Weight, kg	Torque, N*m
50	6,3	425	20	Газ	12+3	18,1	1,8-2,8	0,65	50/100	50	98	135	180	102	88	23	18	366	686	150	175	215	4	130	8	47	0

Legend

DN - Nominal Diameter	T_{max} - Maximum Design Temperature	h - Valve Stroke
PN - Nominal Pressure	M_{кр} - Spindle Torque	K_v - Throughput Capability
P - Pressure	t - Response time	F - Seat Area
	μ - Fluid Flow Coefficient	ζ - Resistance Coefficient

The direct-acting pressure safety valves are intended for the equipment protection against overpressure of the working medium higher than the allowed value.

The valve is closed in case of steam pressure reduction in the site protected up to a definite value of the working pressure.

The choice of the pressure safety valve from the product line, represented in the catalogue, is carried out depending on the working medium parameters in the site protected and the required throughput capability.

The quantity of the pressure safety valves and their throughput capability for general-purpose power supply plants shall be chosen as per calculation according to the Regulatory Technical Documentation agreed with the Federal Service for Environmental, Technological and Nuclear Supervision of the Russian Federation.

Page link:

<https://en.bkzn.ru/catalog/armatura-zashhitnaya/klapany-predoxranitelnye-pryamogo-dejstviya/t-31ms-2/>