

1015-150-ЭК 850-450-ЭН

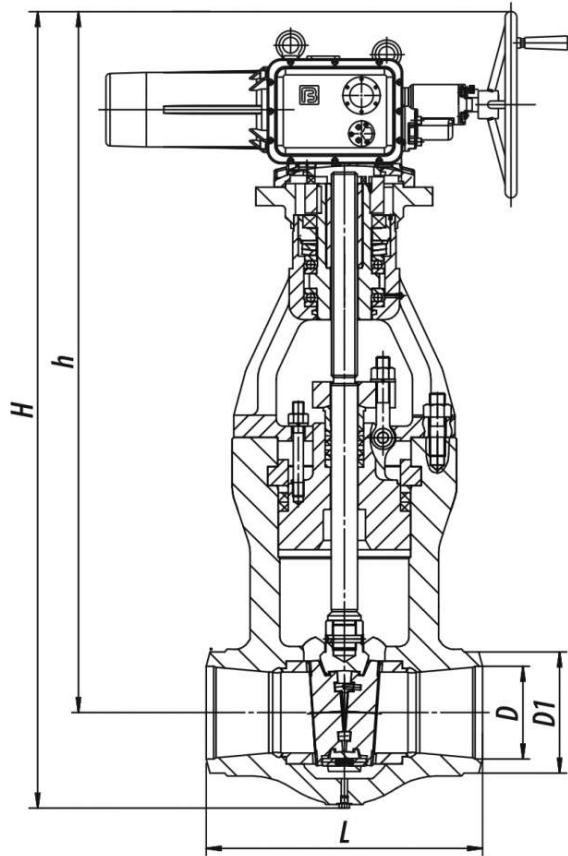

Production according to TR 3740-002-15365247-2004

Pipeline connection: welded connection.

Installation position on the pipeline: any position. When installing gate valves with an electric actuator on vertical areas, an additional mounting support is necessary for the actuator in order to avoid the trolley deformation.

Working medium supply direction: any direction.

Gate sealability: according to class A GOST 9544-2015.

Climatic version: У, ХЛ, УХЛ, Т according to GOST 15150-69.

Placement category: 1, 2, 3 according to GOST 15150-69.

Handwheel force: not more than 300 N.

We can manufacture the gate valves considering specific working conditions upon the customer's demand.

Specifications

DN, mm	PN, MPa	Tmax of the Medium, °C	Body Material, Steel	Working Medium	Operating Stroke, mm	TQ, N·m, maximum torque at spindle plug	ζ, not more than	Full Stroke Rotation Number	L, mm	Differential pressure, MPa, not more than	Control Method	Motor Model	N, kW	t ход а, с.	H, mm	h, mm	D, mm	D1, mm	Weight without Electric Actuator, kg	Full Weight, kg	Torque, N*m
150	9,8*	540	15X1M1Φ	Steam	160	380	0,5	20	500	0,5	Э	MO DAC T MO N 52 033. 321 2N	2,2	48	1312	1130	163	194	307	397	0

Legend

DN - Nominal Diameter
PN - Nominal Pressure
P - Pressure

Tmax - Maximum Design Temperature
Мкп - Spindle Torque
t - Response time

h - Valve Stroke
Kv - Throughput Capability
F - Seat Area
ζ - Resistance Coefficient

μ - Fluid Flow Coefficient

They are only used for turning on and off the pipeline.
The usage of the gate valves as control devices is not allowed.

When using gate valves in the pipelines, wherein the heating-up mode at the closed gate and water-filled internal cavity are provided, they shall be equipped with a discharge device. Such device may be produced in form of a pipe connecting the internal cavity of the gate with the pipeline on the side of the medium supply with a valve DN20 installed thereon, or in form of a through hole with the diameter of 5 mm in the plate on the side of the medium supply.

The valve configuration is adapted to application of electric actuators manufactured by the following companies:

Э – Barnaul Boiler Plant, LLC; CHZEM;
ЭГ – GZ Elektroprivod, Moscow;
ЭЧ – ABS ZEIM Automation, OJSC, Cheboksary;
ЭН – BETRO-Tech, Berdsk;
ЭМ – Tulaelektroprivod, Tula;
ЭК – ZPA Pecky, Czechia;
ЭД – AUMA, Germany;
other manufacturers with standard connection units.

The allowed values of operating pressures and temperatures for the fittings may differ from those ones given in the table with technical specifications and are chosen in accordance with GOST 356-80, provided that they shall not exceed the limits prescribed by the respective State Supervision Rules and Standards for these materials and operation conditions.

According to GOST 356-80, the items designed for the ultimate pressure allow their application on operating parameters within the following range:

at PN 10 MPa – from 10 MPa, 200 °C to 3,6 MPa, 455 °C;
at PN 25 MPa – from 25 MPa, 200 °C to 9 MPa, 455 °C;
at PN 6,3 MPa – from 6,3 MPa, 200 °C to 2,3 MPa, 455 °C.

Page link:

<https://en.bkzn.ru/catalog/armatura-zapornaya/zadvizhki/1015-150-ek/>