

12c-8-14

Production according to TR 3740-002-15365247-2004

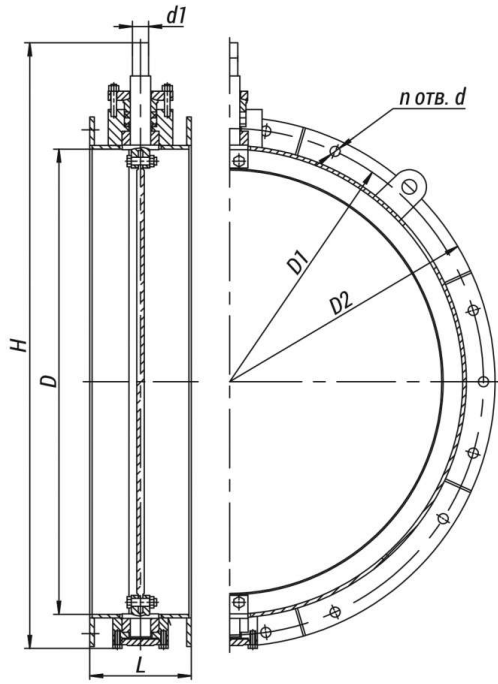

Pipeline connection: flanged connection.
Installation position: on horizontal and vertical pipeline sections.
Climatic version: У, УХЛ, ХЛ, Т according to GOST 15150-69.
Placement category: 2, 3 according to GOST 15150-69.

Specifications

DN, mm	PN, MPa	Tmax of the Medium, °C	Body Material, Steel	Working Medium	Max. Pressure Differential, MPa	F, cm ²	TQ, N·m, maximum torque at spindle plug	Full Stroke Rotation Number	Designation - display in a group	Designation - display in the product table	L, mm	Designation of the electric drive	N, kW	t, sec.	H, mm	h, mm	D, mm	D1, mm	d, mm	D2, mm	n	Weight without Electric Actuator, kg	Full Weight, kg	Updated	S1, cm ²	S2, cm ²	Torque, N·m
1300	0,1	400	09Г2С	Air, gases	112500	12870	1600	0,25	0	0	280	MЭ 0-160/25-0,25y-92K	0,3	25	1583	22	1310	1400	50	1450	28	300	435	0	0	0	0

Legend

DN - Nominal Diameter
PN - Nominal Pressure
P - Pressure

Tmax - Maximum Design Temperature
Мкp - Spindle Torque
t - Response time
μ - Fluid Flow Coefficient

h - Valve Stroke
Kv - Throughput Capability
F - Seat Area
ζ - Resistance Coefficient

The rotary disc valves of type 12c are intended for the flow control of air and compatible stripped gases in the gas and air lines of the boiler unit.

The control is carried out through changing the area of passage section when turning the disc with the help of:

- an actuator of single-turn electric flanged actuator (MЭOΦ) type installed on the top trunnion;
- an actuator of single-turn electric actuator (MЭO) type through the lever.

The full opening of the valve corresponds to the disc turning by an angle of 90 from the closed position.

Page link:

<https://en.bkzn.ru/catalog/armatura-reguliruyushhaya/zatvory-povorotnye-diskovye-tipa-12s/12s-8-14/>