

# 12c-8-10

Production according to TR 3740-002-15365247-2004

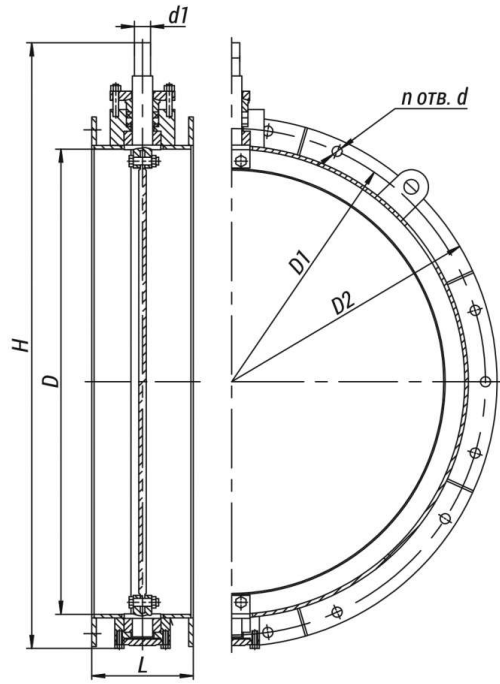

**Pipeline connection:** flanged connection.

**Installation position:** on horizontal and vertical pipeline sections.

**Climatic version:** У, УХЛ, ХЛ, Т according to GOST 15150-69.

**Placement category:** 2, 3 according to GOST 15150-69.

## Specifications

DN, mm	PN, MPa	Tmax of the Medium, °C	Body Material, Steel	Working Medium	Max. Pressure Differential, MPa	F, cm <sup>2</sup>	TQ, N·m, maximum torque at spindle plug	Full Stroke Rotation Number	Designation - display in a group	Designation - display in the product table	L, mm	Designation of the electric drive	N, kW	t, sec.	H, mm	h, mm	D, mm	D1, mm	d, mm	D2, mm	n	Weight without Electric Actuator, kg	Full Weight, kg	Up dated	S1, cm <sup>2</sup>	S2, cm <sup>2</sup>	Torque, N·m
900	0,1	400	09Г2С	Air, gases	51500	6080	630	0,25	0	0	220	MЭ 0-630/25-0,25Y-92K	0,2	25	1183	22	910	1000	40	1050	20	190	264	0	0	0	0

### Legend

**DN** - Nominal Diameter  
**PN** - Nominal Pressure  
**P** - Pressure

**Tmax** - Maximum Design Temperature  
**Мкр** - Spindle Torque  
**t** - Response time  
**μ** - Fluid Flow Coefficient

**h** - Valve Stroke  
**Kv** - Throughput Capability  
**F** - Seat Area  
**ζ** - Resistance Coefficient

**The rotary disc valves of type 12c are intended for the flow control of air and compatible stripped gases in the gas and air lines of the boiler unit.**

**The control is carried out through changing the area of passage section when turning the disc with the help of:**

- an actuator of single-turn electric flanged actuator (MЭOΦ) type installed on the top trunnion;
- an actuator of single-turn electric actuator (MЭO) type through the lever.

The full opening of the valve corresponds to the disc turning by an angle of 90 from the closed position.

**Page link:**

<https://en.bkzn.ru/catalog/armatura-reguliruyushhaya/zatvory-povorotnye-diskovye-tipa-12s/12s-8-10/>