

995-150-ЭаЧ-02

Production according to TR 3740-002-15365247-2004

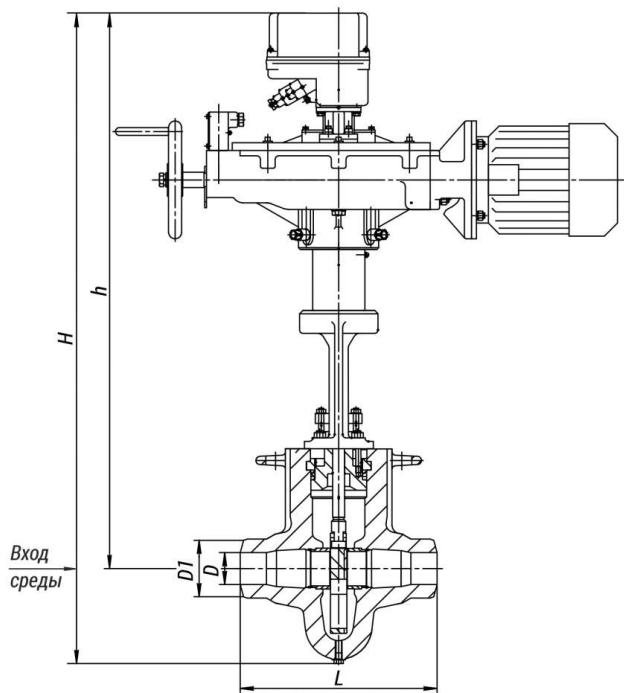

Installation position: on horizontal and vertical pipeline sections with the medium direction from the top downward.

Pipeline connection: welded connection.

Climatic version: У, УХЛ, ХЛ, Т according to GOST 15150-69.

Placement category: 2, 3 according to GOST 15150-69. The valve control is carried out with the help of multi-turn built-in electric actuators with a current position sensor.

Specifications

DN, mm	Pp, MPa	Tmax of the Medium, °C	Body Material, Steel	Working Medium	Operating Stroke, mm	F, cm ²	TQ, N·m, maximum torque at spindle plug	L, mm	Designation of the electric drive	N, kW	t хода, с.	H, mm	h, mm	D, mm	D1, mm	Weight without Electric Actuator, kg	Full Weight, kg	Torque, N·m
150	9,8	540	15X1 М1Ф Л	Пар	17,5	53,4	370,0	600	ПЭМ-В35-1000-25-36У	2,2	42	2030	1740	163	210	473	560	0

Legend

DN - Nominal Diameter
PN - Nominal Pressure
P - Pressure

Tmax - Maximum Design Temperature
Мкр - Spindle Torque
t - Response time
μ - Fluid Flow Coefficient

h - Valve Stroke
Kv - Throughput Capability
F - Seat Area
ζ - Resistance Coefficient

The slide control valves are used at heat power engineering sites for the control of the working medium flow or pressure. The control is performed by means of changing the passage area, which is achieved through translational movement of the slide gate.

The maximum pressure differential on the valve is limited.

Page link:

<https://en.bkzn.ru/catalog/armatura-reguliruyushhaya/klapany-shibernye/995-150-eac-02/>