

# 1087-100-Э-01

Production according to TR 3740-002-15365247-2004

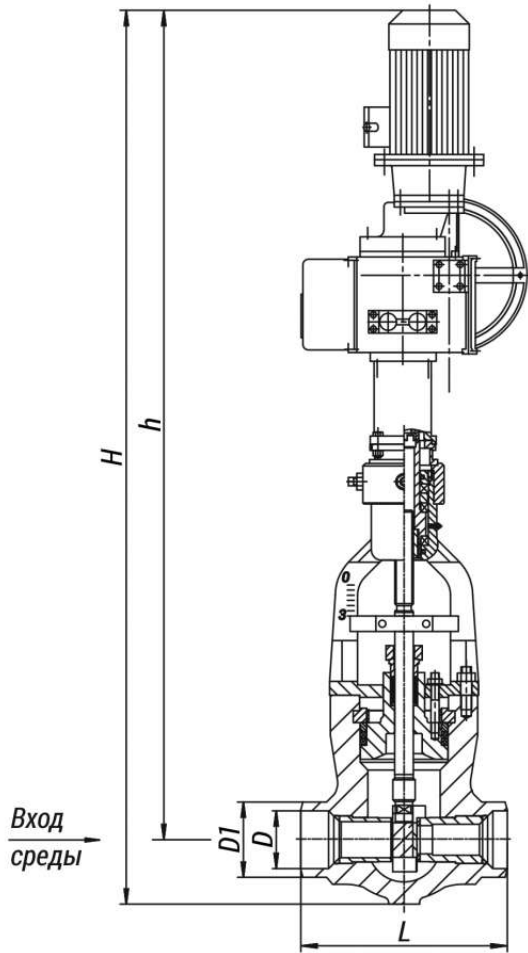

**Installation position:** on horizontal and vertical pipeline sections with the medium direction from the top downward.

**Pipeline connection:** welded connection.

**Climatic version:** У, УХЛ, ХЛ, Т according to GOST 15150-69.

**Placement category:** 2, 3 according to GOST 15150-69. The valve control is carried out with the help of multi-turn built-in electric actuators with a current position sensor.

## Specifications

DN, mm	Pp, MPa	Tmax of the Medium, °C	Body Material, Steel	Working Medium	Operating Stroke, mm	F, cm <sup>2</sup>	TQ, N·m, maximum torque at spindle plug	L, mm	Designation of the electric drive	N, kW	t хода, с.	H, mm	h, mm	D, mm	D1, mm	Weight without Electric Actuator, kg	Full Weight, kg	Torque, N·m
100	13,7	560	15X1 M1Φ	Пар	10	15,5	208	400	792-Э P-0al	1,7	15	1180	1055	94	146	159	233	0

### Legend

**DN** - Nominal Diameter  
**PN** - Nominal Pressure

**Tmax** - Maximum Design Temperature  
**Мкр** - Spindle Torque  
**t** - Response time

**h** - Valve Stroke  
**Kv** - Throughput Capability  
**F** - Seat Area  
**ζ** - Resistance Coefficient

**P** - Pressure

**$\mu$**  - Fluid Flow Coefficient

The slide control valves are used at heat power engineering sites for the control of the working medium flow or pressure. The control is performed by means of changing the passage area, which is achieved through translational movement of the slide gate.

The maximum pressure differential on the valve is limited.

**Page link:**

<https://en.bkzn.ru/catalog/armatura-reguliruyushhaya/klapany-shibernye/1087-100-e-01/>