

1084-100-Эа-02

Production according to TR 3740-002-15365247-2004

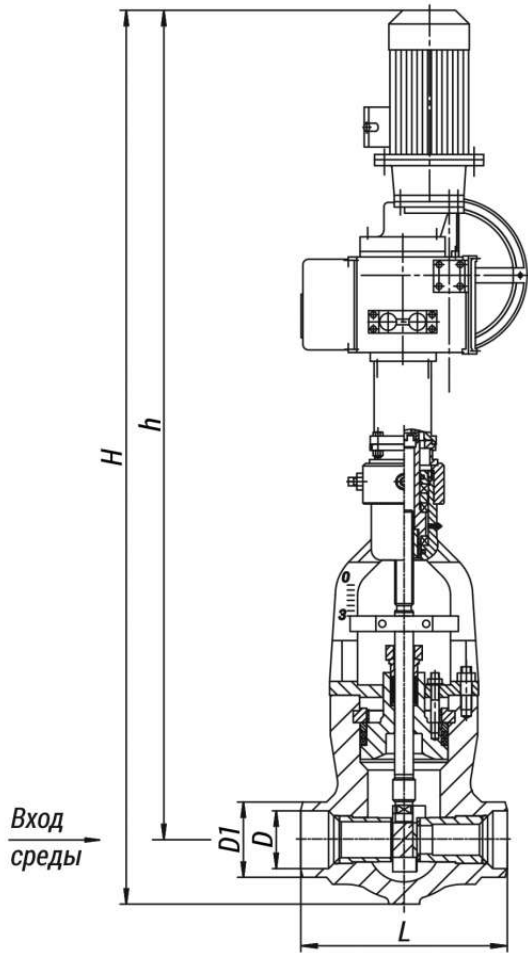

Installation position: on horizontal and vertical pipeline sections with the medium direction from the top downward.

Pipeline connection: welded connection.

Climatic version: У, УХЛ, ХЛ, Т according to GOST 15150-69.

Placement category: 2, 3 according to GOST 15150-69. The valve control is carried out with the help of multi-turn built-in electric actuators with a current position sensor.

Specifications

DN, mm	Pp, MPa	Tmax of the Medium, °C	Body Material, Steel	Working Medium	Operating Stroke, mm	Max. Steam Flow at Critical Pressure Differential, t/h	Max. Kv, m³/h	F, cm²	TQ, N·m, maximum torque at spindle plug	L, mm	Designation of the electric drive	N, kW	t хода, с.	H, mm	h, mm	D, mm	D1, mm	Weight without Electric Actuator, kg	Full Weight, kg	Torque, N·m
100	37,3	280	20	Вода	10,0	7	36,3	9,5	356,7	400	792-ЭП-0а	1,32	30	1180	1055	98	146	159	233	0

Legend

DN - Nominal

Tmax - Maximum

h - Valve Stroke

Diameter	Design Temperature	Kv - Throughput Capability
PN - Nominal Pressure	Mкр - Spindle Torque	F - Seat Area
P - Pressure	t - Response time	ζ - Resistance Coefficient
	μ - Fluid Flow Coefficient	

The slide control valves are used at heat power engineering sites for the control of the working medium flow or pressure. The control is performed by means of changing the passage area, which is achieved through translational movement of the slide gate.

The maximum pressure differential on the valve is limited.

Page link:

<https://en.bkzn.ru/catalog/armatura-reguliruyushhaya/klapany-shibernye/1084-100-ea-02/>