

24c-40-Э

Production according to TR 2913-001-15365247-2004

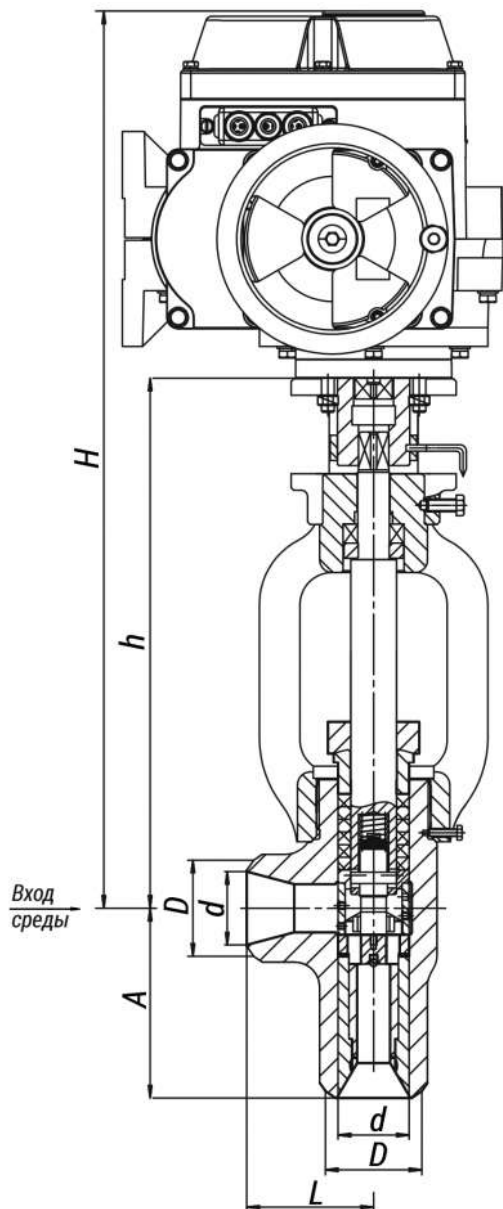

Pipeline connection: welded connection.
Climatic version: У, УХЛ, ХЛ, Т according to GOST 15150-69.
Placement category: 3, 4, 5 according to GOST 15150-69.
Installation position on the pipeline: horizontal.
Working medium supply direction: to the seat. According to the arrow on the body.
Gate sealability: class IV GOST 9544-2015.
The control is carried out through:

- built-in electric actuators of single-turn electric flanged actuator type (МЭОФ) manufactured by ABS ZEIM Automation, OJSC, Cheboksary;
- electric actuators of other manufacturers with standard connection units.

Specifications

DN, mm	Pp, MPa	Tmax of the Medium, °C	Body Material, Steel	Working Medium	Max. Pressure Differential, MPa	F, cm ²	Maximum Steam Rate, t/h	TQ, N·m, maximum torque at spindle plug	Designation - display in a group	Designation - display in the product table	L, mm	Designation of the electric drive	N, kW	т х о да, с.	H, mm	h, mm	D, mm	d, mm	Weight without Electric Actuator, kg	Full Weight, kg	Updated	S1, cm ²	S2, cm ²	Torque, N·m
40	37,3	280	20	вода	7,0	по ТЗ Зак	90	250	0	0	120	МЭОФ-250	0,25	25	650	335	57	39	45	69	0	0	0	0

DN, mm	Pp, MPa	Tmax of the Medium, °C	Body Material, Steel	Working Medium	Max. Pressure Differential, MPa	F, cm ²	Maximum Steam Rate, t/h	TQ, Nm, maximum torque at spindle plug	Designation - display in a group	Designation - display in the product table	L, mm	Designation of the electric drive	N, kW	tход, с.	H, mm	h, mm	D, mm	d, mm	Weight without Electric Actuator, kg	Full Weight, kg	Updated	S1, cm ²	S2, cm ²	Torque, N*m	
						азч ика от 0,0 5 до 4,4 6						/25- 0,2 5Y- 99K													

Legend

DN - Nominal Diameter
PN - Nominal Pressure
P - Pressure

Tmax - Maximum Design Temperature
Мкр - Spindle Torque
t - Response time
μ - Fluid Flow Coefficient

h - Valve Stroke
Kv - Throughput Capability
F - Seat Area
ζ - Resistance Coefficient

The temperature control angle disc valves DN 20-65 of type 24c are intended for the steam temperature control.

They are used for the control of steam superheating temperature on boilers, reduced steam temperature in DS, PRDS, FRPRDS of power generating units and other pipelines, as well as on continuous blowdown pipelines.

Page link:

<https://en.bkzn.ru/catalog/armatura-reguliruyushhaya/klapany-regulyatory-temperatury-uglovye-diskovye-tipa-24s/24s-40-e/>