

# 22c-32-1-3

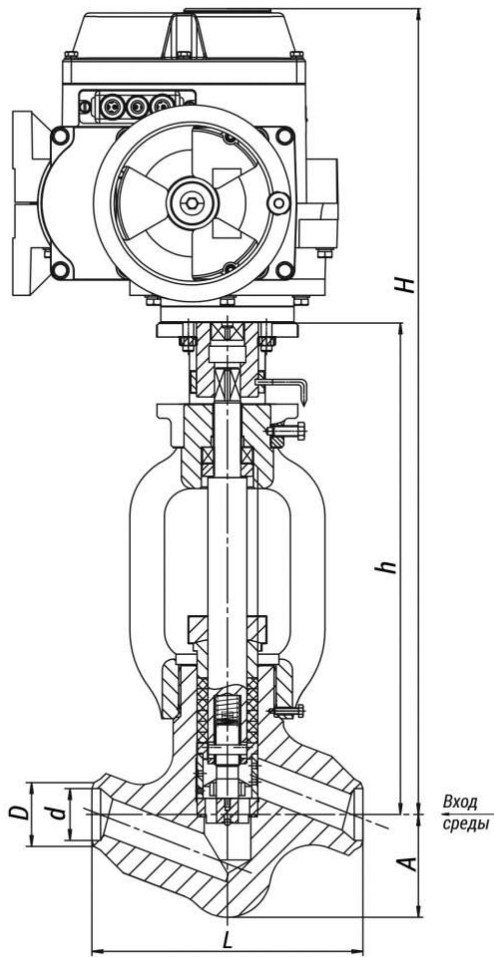

Production according to TR 2913-001-15365247-2004

**Pipeline connection:** welded connection.

**Climatic version:** У, УХЛ, Т according to GOST 15150-69.

**Placement category:** 3, 4, 5 according to GOST 15150-69.

Installation position on the pipeline: horizontal.

Working medium supply direction: to the seat.

According to the arrow on the body.

**Gate sealability:** class IV GOST 9544-2015.

**The control is carried out through:**

- ☒ built-in electric actuators of single-turn electric flanged actuator type (МЭОФ) manufactured by ABS ZEIM Automation, JSC, Cheboksary;

- ☒ electric actuators of other manufacturers with standard connection units.

## Specifications

DN, mm	Pp, MPa	Tmax of the Medium, °C	Body Material, Steel	Working Medium	Max. Pressure Differential, MPa	F, cm <sup>2</sup>	Maximum Steam Rate, t/h	TQ, N·m, maximum torque at spindle plug	Designation - display in a group	Designation - display in the product table	L, mm	Designation of the electric drive	N, kW	tход, с.	H, mm	h, mm	D, mm	d, mm	Weight without Electric Actuator, kg	Full Weight, kg	Updated	S1, cm <sup>2</sup>	S2, cm <sup>2</sup>	Torque, N·m
32	25	545	12X1MФ	пар	по ТЗ Заказчика от 0,2 до 14,6	по ТЗ Заказчика от 0,05 до 4,46	90	250	0	0	250	МЭОФ-250/25-0,25У-99К	0,25	25	95	450	57	31	45	69	0	0	0	0

## Legend

<b>DN</b> - Nominal Diameter	<b>T<sub>max</sub></b> - Maximum Design Temperature	<b>h</b> - Valve Stroke
<b>PN</b> - Nominal Pressure	<b>M<sub>кп</sub></b> - Spindle Torque	<b>K<sub>v</sub></b> - Throughput Capability
<b>P</b> - Pressure	<b>t</b> - Response time	<b>F</b> - Seat Area
	<b>μ</b> - Fluid Flow Coefficient	<b>ζ</b> - Resistance Coefficient

### Temperature Control Process Disc Valves DN 20-65 of Type 22c

The temperature control process disc valves DN 20-65 of type 22c are intended:

☒ for the steam temperature control in the boiler circuit as injection valves;

☒ for the reduced steam temperature control in DS, PRS, FRPRDS of power generating units and other pipelines, as well as on continuous blowdown pipelines.

### Page link:

<https://en.bkzn.ru/catalog/armatura-reguliruyushhaya/klapany-regulyatory-temperatury-tipa-22s/22s-32-1-e/>