

1416-250-P-02

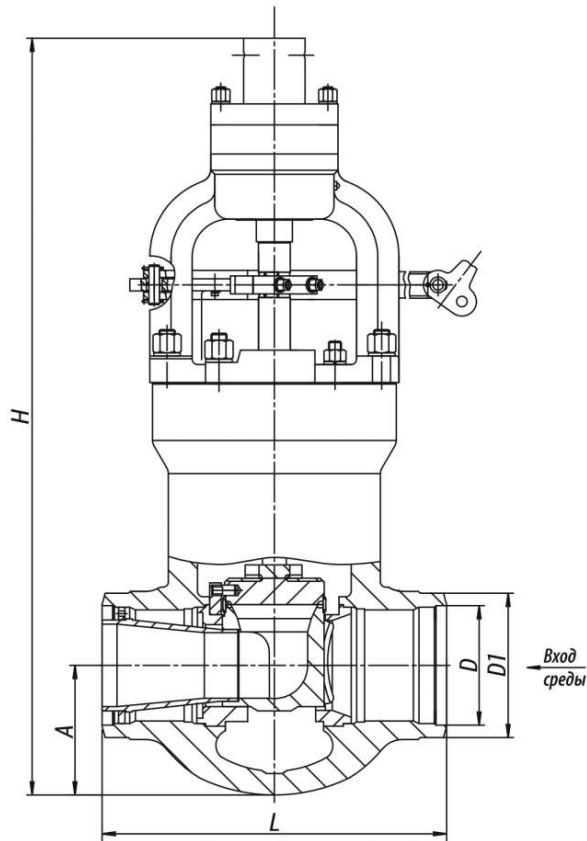

Specifications

DN, mm	Pp, MPa	Tmax of the Medium, °C	Body Material, Steel	Working Medium	Max. Kv, m³/h	Max. Pressure Differential, MPa	TQ, N·m, maximum torque at spindle plug	L, mm	Designation of the electric drive	N, kW	t хода, с.	H, mm	D, mm	D1, mm	A, mm	Weight without Electric Actuator, kg	Full Weight, kg	Torque, N·m
250	23,5	250	15ГC	Вода	146	17,6	1600	650	МЭ0-1600/25-0, 25Y-9 2K	0,49	25	1396	271	340	210	963	1098	0

Legend

DN - Nominal Diameter

PN - Nominal Pressure

P - Pressure

Tmax - Maximum Design Temperature

Мкр - Spindle Torque

t - Response time

μ - Fluid Flow Coefficient

h - Valve Stroke

Kv - Throughput Capability

F - Seat Area

ζ - Resistance Coefficient

Page link:

<https://en.bkzn.ru/catalog/armatura-reguliruyushhaya/klapany-razgruzhennye-1416/1416-250-r-02/>