

# 1416-225-P-03

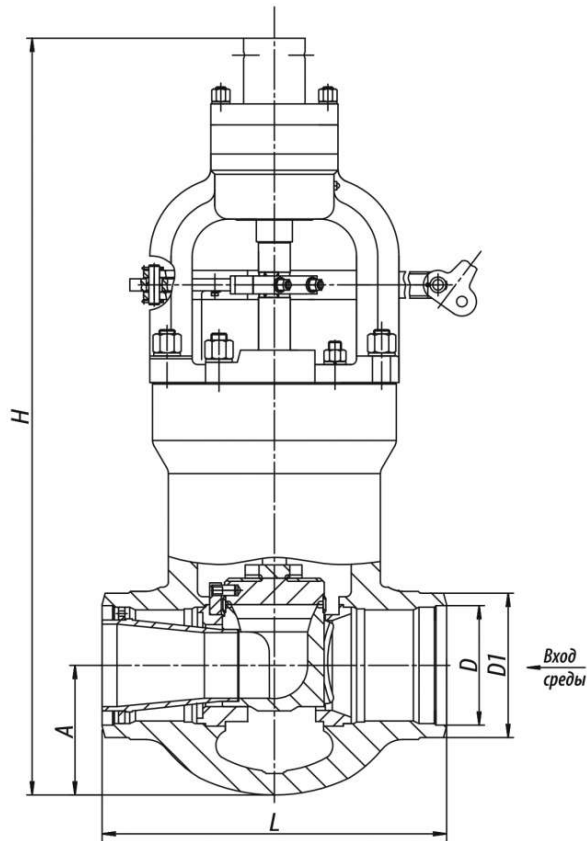

## Specifications

DN, mm	Pp, MPa	Tmax of the Medium, °C	Body Material, Steel	Working Medium	Max. Kv, m³/h	Max. Pressure Differential, MPa	TQ, N·m, maximum torque at spindle plug	L, mm	Designation of the electric drive	N, kW	t хода, с.	H, mm	D, mm	D1, mm	A, mm	Weight without Electric Actuator, kg	Full Weight, kg	Torque, N·m
225	23,5	250	15ГC	Вода	77	17,6	1600	650	МЭ0-1600/25-0, 25Y-9 2K	0,49	25	1431	226	285	245	953	1088	0

### Legend

**DN** - Nominal Diameter

**PN** - Nominal Pressure

**P** - Pressure

**Tmax** - Maximum Design Temperature

**Мкр** - Spindle Torque

**t** - Response time

**μ** - Fluid Flow Coefficient

**h** - Valve Stroke

**Kv** - Throughput Capability

**F** - Seat Area

**ζ** - Resistance Coefficient

**Page link:**

<https://en.bkzn.ru/catalog/armatura-reguliruyushhaya/klapany-razgruzhennye-1416/1416-225-r-03/>