

1438-20-Э-01

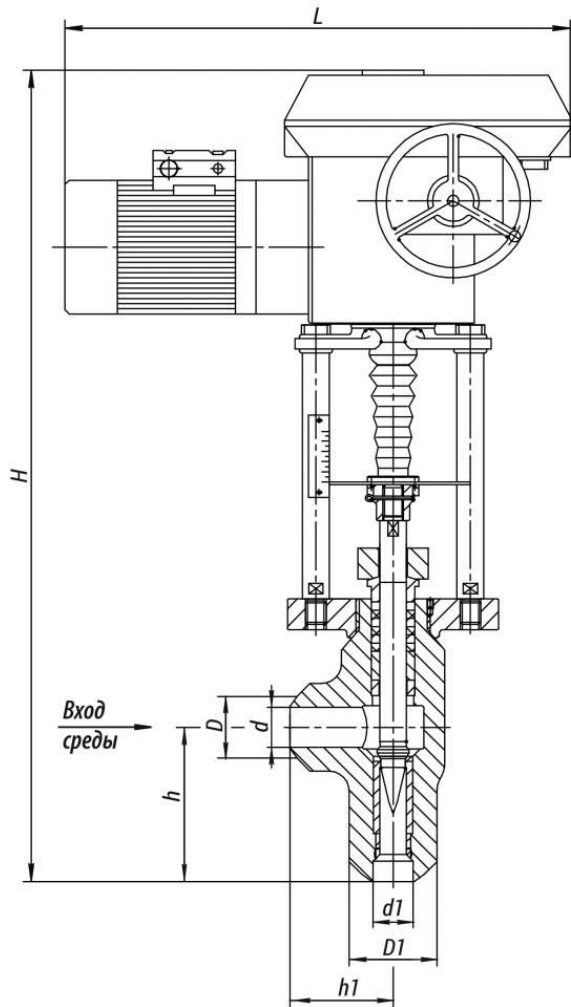

Production according to TR 2913-001-15365247-2004

Installation place: as a rule, the valves are installed on the cooling water injection pipelines in DS, PRDS, FRPRDS and industrial pipelines. Installation requirements: the valves are designed for outdoor installation and in closed premises with the ambient temperature up to +70 C.

The valves equipped with built-in actuators shall be only installed on horizontal pipeline sections with the actuator position upwards.

Pipeline connection: welded connection.

Climatic version: У, УХЛ, ХЛ, Т according to GOST 15150-69.

Placement category: 1, 2, 3 according to GOST 15150-69.

Depending on the lifting height of the valve needle, the throughput capability is shown in the diagrams.

Specifications

DN, mm	Pp, MPa	Tmax of the Medium, °C	Body Material, Steel	Working Medium	Operating Stroke, mm	Max. Kv, m ³ /h	Max. Pressure Differential, MPa	F, cm ²	TQ, N·m, maximum torque at spindle plug	d1, mm	Designation of the electric drive	N, kW	тход, с.	H, mm	h, mm	D, mm	D1, mm	d, mm	h1, mm	Weight without Electric Actuator, kg	Full Weight, kg	Torque, N·m
20	37,3	280	20	Вода	29	2,7	4	0,51	20кН*	28	МЭ П-2 500 0/1 00-5 0-У-99	0,3	58	905	115	32	45	20	70	13	38	0

Legend

DN - Nominal Diameter	T_{max} - Maximum Design Temperature	h - Valve Stroke
PN - Nominal Pressure	M_{кр} - Spindle Torque	K_v - Throughput Capability
P - Pressure	t - Response time	F - Seat Area
	μ - Fluid Flow Coefficient	ζ - Resistance Coefficient

The control needle valves are used as fluid flow regulators.

The provision of smooth control within the limits of the rated throughput capability is achieved with the help of the valve needle form. The seat has reinforced hard-facing of increased hardness which is resistant to erosive and corrosive wear. They are not used as shutoff devices.

According to the actuator type of the working body and control method, the control needle valves are divided into the following types:

- Lever-operated control needle valves. The valve control is carried out on a remote basis (automatically) with actuators of single-turn electric actuator type (МЭО) through the lever. The allowed pressure differential on the valve shall not exceed 1 MPa.
- Control needle valves. The valve control is carried out with a handwheel or an actuator with a current position sensor of electric multi-turn actuator types (ПЭМ) (ABS ZEIM Automation), SAR (AUMA) or linear pneumatic actuators FESTO, VALBIA, AIR Torque, ROTORK etc., chosen considering the working medium pressure and air pressure. The valves equipped with actuators shall be only installed on horizontal pipeline sections with the actuator position upwards.
- Control angle valves. The valves are controlled with a built-in multi-turn electric actuator with a current position sensor of electric multi-turn actuator / electric multi-turn mechanism types (ПЭМ/МЭМ) (ABS ZEIM Automation), SAR (AUMA) etc. or linear pneumatic actuators of electric multi-turn actuator types (МЭП) (ABS ZEIM Automation), REGADA etc., chosen considering the working medium pressure.

According to GOST 356-80, the valves designed for the ultimate pressure allow their application on operating parameters within the following range:

- at PN 100 MPa – from 10 MPa, 200 °C to 3,6 MPa, 455 °C;
- at PN 63 MPa – from 6,3 MPa, 200 °C to 2,3 MPa, 455 °C;
- at PN 25 MPa – from 25 MPa, 200 °C to 9 MPa, 455 °C.

Page link:

<https://en.bkzn.ru/catalog/armatura-reguliruyushhaya/-/1438-20-e-01/>